

COMPLETE RESAW FENCE FOR G0514 MODEL H7589

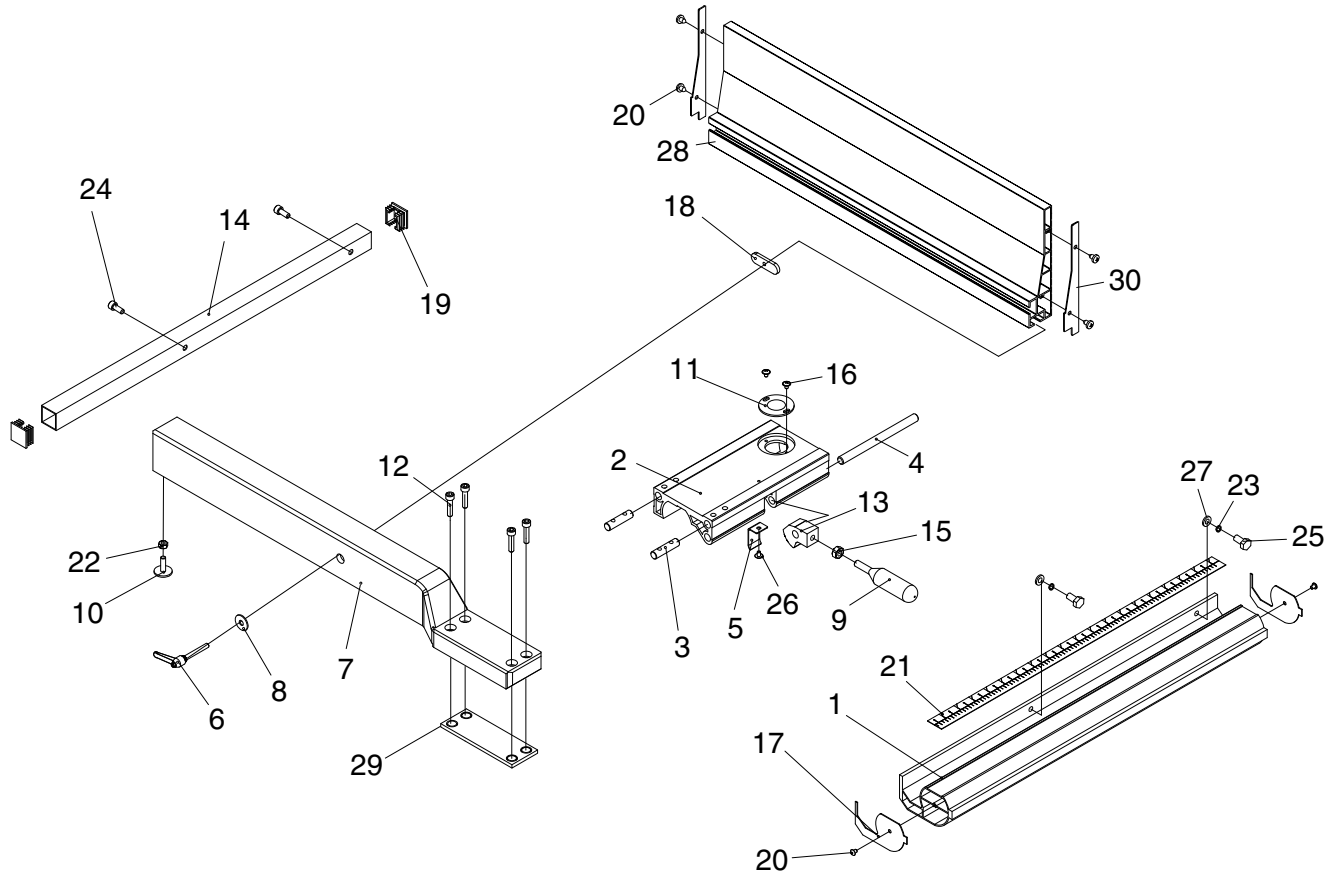

REF	PART #	DESCRIPTION
1	PH7589001	FIXED BASE 710mm
2	PH7587002	ADJUST BASE
3	PH7587003	FIXED SHAFT
4	PH7587004	SHAFT
5	PH7587005	SPRING PIECE
6	PH7528004	ADJUSTMENT HANDLE M8 X 44
7	PH7589007	SUPPORT TUBE 640mm
8	PW01M	FLAT WASHER 8MM
9	PH7587009	HANDLE
10	PH7587010	ADJUST SCREW
11	PH7587011	CONVEX
12	PSB07M	CAP SCREW M6-1 X 30
13	PH7587013	FIXED LUMP
14	PH7589014	SQUARE TUBE 710mm
15	PN03M	HEX NUT M8-1.25

REF	PART #	DESCRIPTION
16	PFS04M	FLANGE SCREW M4-.7 X 6
17	PH7587017	GUARD PIECE
18	PH7528002	MOVING PLATE
19	PH7587019	PLUG
20	PHTEK3M	TAP SCREW M3.5 X 8
21	PH7587021	SCALE
22	PN01M	HEX NUT M6-1
23	PLW03M	LOCK WASHER 6MM
24	PSB01M	CAP SCREW M6-1 X 16
25	PB08M	HEX BOLT M6-1 X 20
26	PFB11M	FLANGE BOLT M4-.7 X 10
27	PW03M	FLAT WASHER 6MM
28	PH7589028	RESAW FENCE (AL) 640mm
29	PH7587029	SPACER PLATE
30	PH7528005	END COVER 148 X 22 X 1

COPYRIGHT © JUNE, 2005 BY GRIZZLY INDUSTRIAL, INC. REVISED NOVEMBER, 2006.

WARNING: NO PORTION OF THIS MANUAL MAY BE REPRODUCED IN ANY SHAPE OR FORM WITHOUT THE WRITTEN APPROVAL OF GRIZZLY INDUSTRIAL, INC.

#TR7296 PRINTED IN TAIWAN